

 Dell Technologies



 NVIDIA®

 intel®

# Engineering and Manufacturing in the Modern Era.

The way products and structures are developed and built is changing, thanks to advances in simulation, analysis, digital twins, generative design, and artificial Intelligence. Collaboration is improving too, with augmented and virtual reality (AR & VR), and photo-real visualizations.

As new technologies are introduced, projects become more complex. We'll help you support these vital industry workflows.

See the most common industry workflows next:





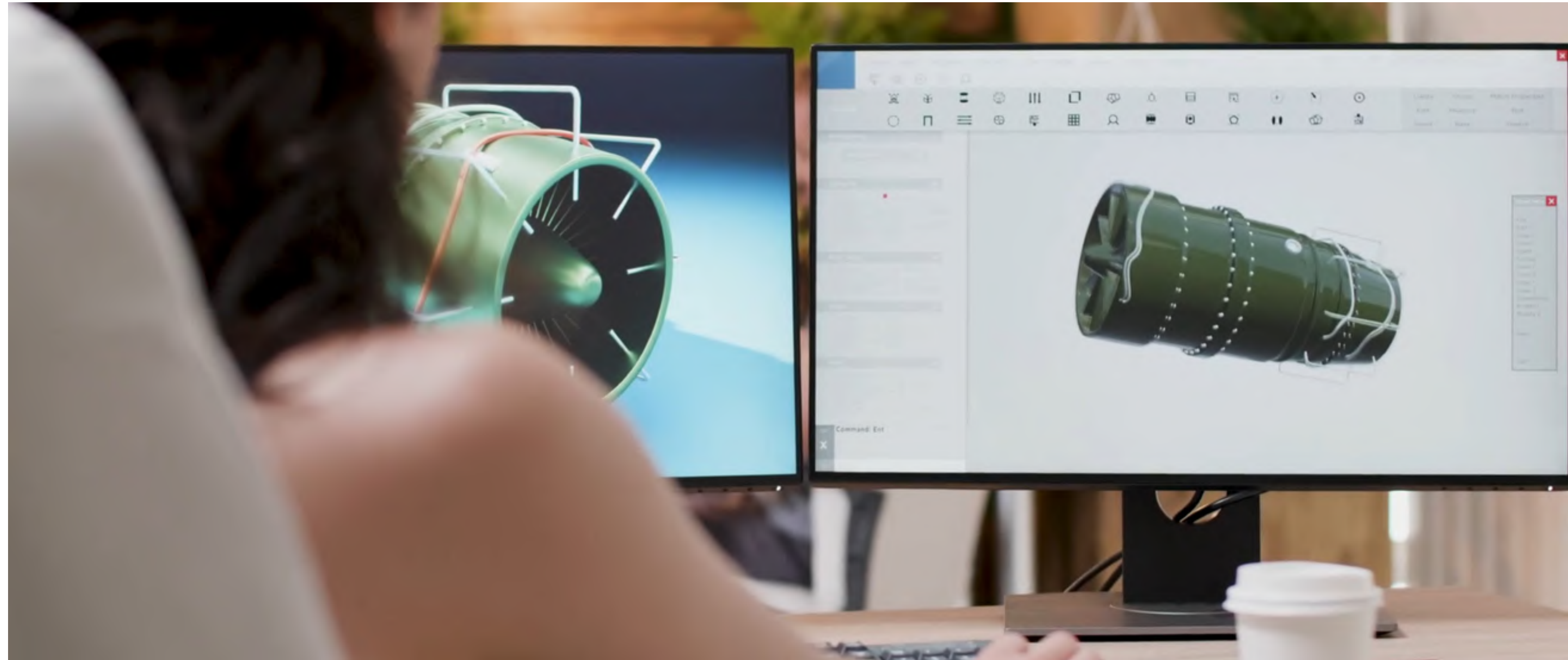











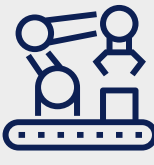

































## Engineering and Manufacturing Workflow



To compete in a world where production is moving from commoditization to personalization, today's leading engineers and manufacturers need to streamline workflows using high performance workstations. The challenge is doing that effectively while incorporating new technologies such as IoT, reducing physical prototypes and enhancing collaboration.

# Engineering and Manufacturing Workflow

 CONCEPT DESIGN <b>Quickly evaluate design options.</b>	 SYSTEMS DESIGN <b>Define major systems and how they work together.</b>	 INDUSTRIAL DESIGN <b>Define shape, look and feel, user interaction.</b>	 DETAILED DESIGN <b>Define design in full detail.</b>	 SIMULATION / ANALYSIS (CAE) <b>Evaluate performance to meet specifications.</b>	 VISUALIZATION <b>Simulate visual experience.</b>	 MANUFACTURING (CAM) <b>CNC Machining, create tool paths / additive MFG.</b>
Dassault Systèmes® SolidWorks® 	Autodesk Inventor® 	Autodesk Alias® Studio	Autodesk Inventor® 	ANSYS® Discovery® 	Autodesk 3ds Max®	Autodesk HSMWorks
Dassault Systèmes® CATIA® Natural Sketch 	Autodesk Fusion™	Dassault Systèmes® SolidWorks® 	Autodesk Fusion™	ANSYS® Mechanical™ 	Dassault Systèmes® SolidWorks® Visualize 	MasterCAM
Autodesk AutoCAD® 	Dassault Systèmes® SolidWorks® 	Dassault Systèmes® SolidWorks® 	Dassault Systèmes® SolidWorks® 	ANSYS® Fluent® 	Dassault Systèmes® 3DExcite	Dassault Systèmes® DELMIA
SketchBook® Pro	Dassault Systèmes® CATIA® 	Dassault Systèmes® CATIA® Industrial Design 	Dassault Systèmes® CATIA® 	Autodesk Inventor® 	Dassault Systèmes® 3DExcite	Dassault Systèmes® SolidWorks® CAM 
PTC Creo® DEX 	Dassault Systèmes® CATIA® 	PTC Creo® 	Dassault Systèmes® CATIA® 	Autodesk Fusion™	Dassault Systèmes® CATIA® 	PTC Creo® 
PTC Creo® Sketch 	PTC Creo® 	Siemens NX™ 	PTC Creo® 	Dassault Systèmes® SolidWorks® 	PTC Creo® Render Studio 	PTC Creo® 
ANSYS® SpaceClaim® 	Siemens NX™ 	Autodesk Inventor	Siemens NX™ 	Dassault Systèmes® SolidWorks® 	Siemens NX Ray Traced Studio 	Siemens NX™ CAM 
Siemens Solid Edge 			Siemens Solid Edge	Dassault Systèmes® CATIA® 	Siemens TCVis™	SolidCAM
Siemens NX Mechatronics Concept Designer				PTC Creo® 		Vero Software EDGECAM
				Siemens NX™ 		Hexagon SURFCAM
				Siemens Simcenter		

See Dell solutions below:

PRODUCT DESIGN

SIMULATION AND ANALYSIS

VISUALIZATION

COMPUTER AIDED MANUFACTURING

## Precision 3680 Tower

Extreme scalability in mini-tower design.

Dell Precision 3680 Tower workstation delivers scalable performance for 2D and 3D CAD applications, such as: Dassault Systèmes® – SolidWorks® and CATIA®, Autodesk Inventor®, Autodesk AutoCAD®, PTC Creo® and Siemens NX™.

**You won't believe your eyes:** Whether you're working on CAD, CAE, CAM or visualization tasks, Intel integrated graphics or up to AMD Radeon Pro or NVIDIA pro graphics (up to 450W) ensure a smooth and elevated visual experience every time and GPU accelerated performance where available.

**Slowing down isn't an option:** Up to Intel Core i9k, 24 (8P + 16E) Core™ processors for quick response on interactive workloads and exceptional compute performance on computational workloads. Up to NVIDIA RTX 6000 Ada graphics for complex / graphics intensive tasks and up to 128GB of DDR5 memory to support large datasets. Up to 28TB of RAID capable storage including PCIe NVMe™ Class 40 Gen4 SSDs for fast performance.

**Convenient connectivity:**

Available Wi-Fi 6 and Bluetooth 5.2 with vPro.



### 3Dconnexion SpaceMouse Pro

With an advanced ergonomic design and on-screen display, SpaceMouse Pro delivers superior comfort and a simpler, more productive workflow.

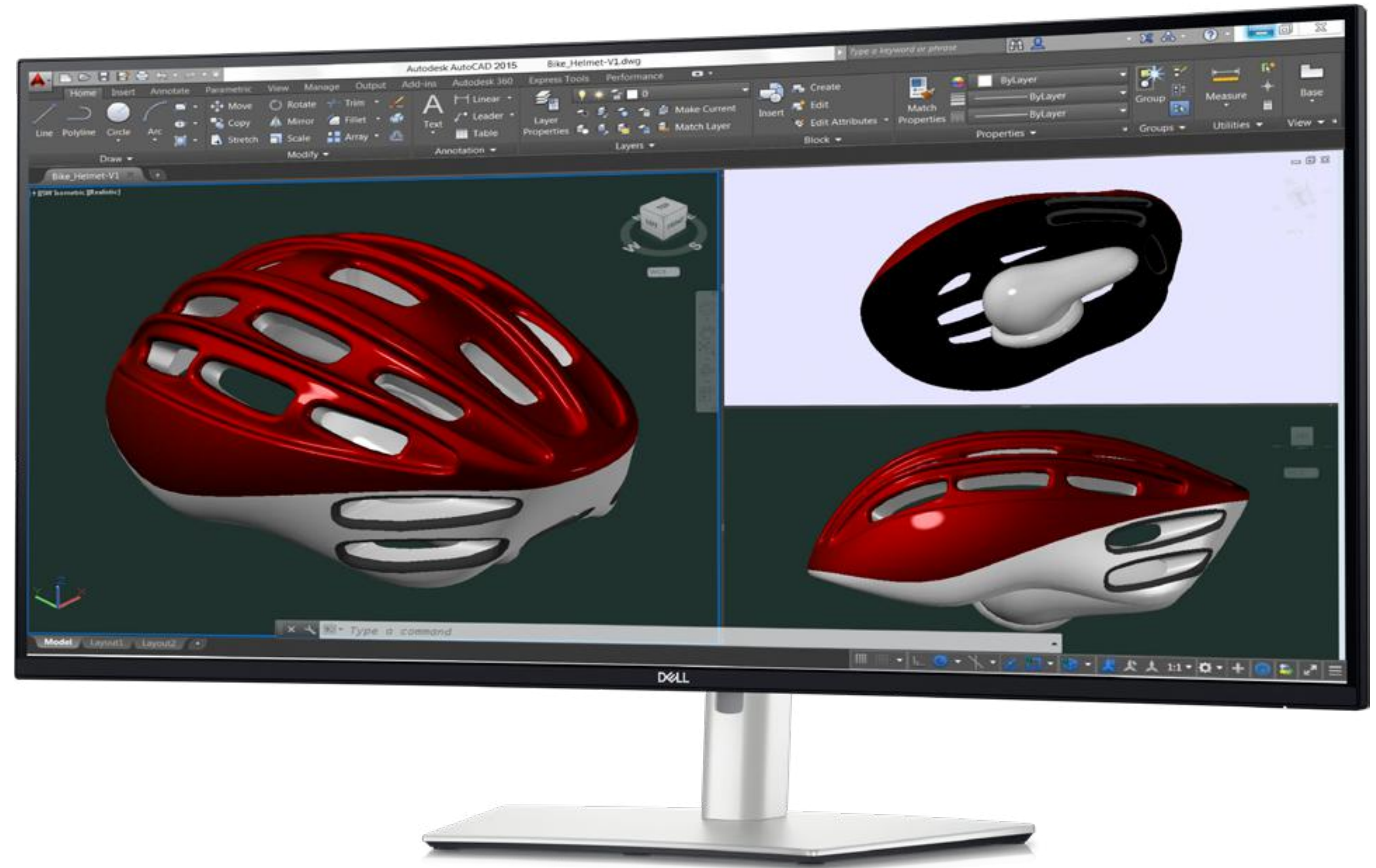

### Dell UltraSharp 40 Curved WUHD Monitor | U4025QW

Redefine productivity on this revolutionary 40" curved WUHD 5K2K monitor that delivers 99% DCI-P3 color and clarity.

### Dell Pro Wireless Keyboard and Mouse | KM5221W

Combining a discreetly powerful keyboard with an expertly designed mouse, the Dell Pro Wireless Keyboard and Mouse combo enhances your productivity. Powered by one of the industry's leading battery lives of up to 36 months, this combo is built to last.

## Precision 7680

Dell's most powerful 16" workstation just got stronger.

Dell Precision 7680 Tower workstation delivers scalable performance for 2D and 3D CAD applications, such as: Dassault Systèmes® – SolidWorks® and CATIA®, Autodesk Inventor®, Autodesk AutoCAD®, PTC Creo® and Siemens NX™.

**Innovate without interruption:** Up to 13th Gen Intel® Core™ i9 HX (55w) processors, 24 cores (8P +16E).

**Make everything stand out:** Choose up to 16GB NVIDIA® RTX™ A5000-class graphics.

**Stay cool, calm and productive:** Optimize performance with advanced thermals featuring dual opposing output fans and user selectable thermal tables.

**No idea is too big:** Store your work confidently with up to 12TB of storage and up to 128GB of memory via CAMM and NECC DDR5 memory.





### Dell Pro Wireless Headset | WL5024

Enjoy wireless freedom away from your PC with this Teams certified headset that offers convenient call controls and built-in noise cancelling.

### Dell Performance Dock | WD19DCS

Boost your PC's power up to 210W on the world's most powerful and first modular Dual USB-C dock with a future-ready design.



### Dell Premier Multi-Device Wireless Keyboard and Mouse | KM7321W

Multi-task seamlessly across 3 devices with this premium full-size keyboard and sculpted mouse combo featuring programmable shortcuts and 36 months battery life.



### Dell UltraSharp 32 4K USB-C Hub Monitor | U3223QE

Be your most productive on a 31.5" 4K monitor with brilliant color and contrast that features groundbreaking IPS Black technology for detailed linework and a connectivity hub.



### 3Dconnexion SpaceMouse Wireless

This easy to carry wireless device, has a patented 6-Degrees-of-Freedom (6DoF) sensor that allows you to rotate, zoom and manipulate.





## Precision 7875 Tower

Amplify your productivity.

The Dell Precision 7875 Tower workstation delivers scalable performance for CAE applications, such as: ANSYS® Mechanical™, Fluent®, Discovery™ Live, Altair® HyperWorks®, solidThinking® and COMSOL Multiphysics®. AI and VR ready.

**Powerful performance:** Run demanding multithreaded engineering applications with up to a 96 cores 350W AMD Ryzen Threadripper Processor.

**Best-in-class graphics:** Support advanced engineering and artificial intelligence GPU workloads with up to two 300W graphic cards. An extensive range of professional AMD and NVIDIA graphic options are available.

**Elevate your purpose:** Power your system with an up to 1350W PSU.



### Dell Webcam | WB3023 | 2K QHD

Collaborate confidently with this 2K QHD webcam that's essential for everyday use.



### Dell Premier Multi-Device Wireless Keyboard and Mouse – KM7321W

Elegantly designed to enhance your productivity and fit into virtually any workspace. Simultaneously pair up to two compatible devices with Bluetooth® LE for increased versatility.



### Dell UltraSharp 32 4K USB-C Hub Monitor | U3223QE

Be your most productive on a 31.5" 4K monitor with brilliant color and contrast that features groundbreaking IPS Black technology for detailed linework and a connectivity hub.

# Mobile Simulation and Analysis (CAE)

## Precision 7780

Power your passion with the performance of Precision.

The Dell Precision 7770 workstation delivers scalable performance for CAE applications, such as: ANSYS® Mechanical™, Fluent®, Discovery™ Live, Altair® HyperWorks®, solidThinking® and COMSOL Multiphysics®. AI and VR ready.

**Innovate without interruption:** Up to 13th Gen Intel® Core™ i9 HX (55W) processors, 24 cores (8P +16E).

**Make Power GPU hungry applications stand out:** Choose up to 16GB NVIDIA® RTX™ A5000-class graphics.

**Stay cool, calm and productive:** Optimize performance with advanced thermals featuring dual opposing output fans and user selectable thermal tables.

**No idea is too big:** Store your work confidently with up to 16TB of storage and up to 128GB of DDR5 memory.



### Dell Premier Multi-Device Wireless Keyboard and Mouse | KM7321W

Multi-task seamlessly across 3 devices with this premium full-size keyboard and sculpted mouse combo featuring programmable shortcuts and 36 months battery life.



### 3Dconnexion SpaceMouse Wireless

This easy to carry wireless device, has a patented 6-Degrees-of-Freedom (6DoF) sensor that allows you to rotate, zoom and manipulate.



### Dell UltraSharp 32 HDR PremierColor Monitor | UP3221Q

Create phenomenal 4K HDR content on the world's first professional monitor with 2K mini-LED direct backlit dimming zones.\*



### Dell Performance Dock | WD19DCS

Boost your PC's power up to 210W on the world's most powerful and first modular Dual USB-C dock with a future-ready design.



### HTC Vive Pro 2

Review rendered projects in virtual reality and allow clients to experience a realistic interpretation of the finished product.

## Precision 7960 Tower

### Take your productivity to new heights

The Dell Precision 7960 Tower workstation delivers scalable performance for visualization applications, such as: Dassault Systèmes® – SolidWorks® Visualize, 3DEXCITE, Autodesk® 3ds Max® and VRED Siemens PLM Teamcenter

**Tear through your work:** With Intel XEON and up to 56 cores you will excel the performance of your multi-threaded applications.

**Best-in-class graphics:** Get more done within your project schedule with up to four 300W graphic cards. A full scale of professional AMD and NVIDIA graphic options are available.

**Scalable performance:** Get up to 1TB of memory and 56TB of storage.



### Dell UltraSharp Webcam | WB7022

Elevate your video conferencing experience on this powerful, intelligent 4K webcam that optimizes your visuals with a large 4K Sony STARVIS™ CMOS sensor and AI Auto-Framing.



### 3Dconnexion SpaceMouse Pro

With an advanced ergonomic design and on-screen display, SpaceMouse Pro delivers superior comfort and a simpler, more productive workflow.

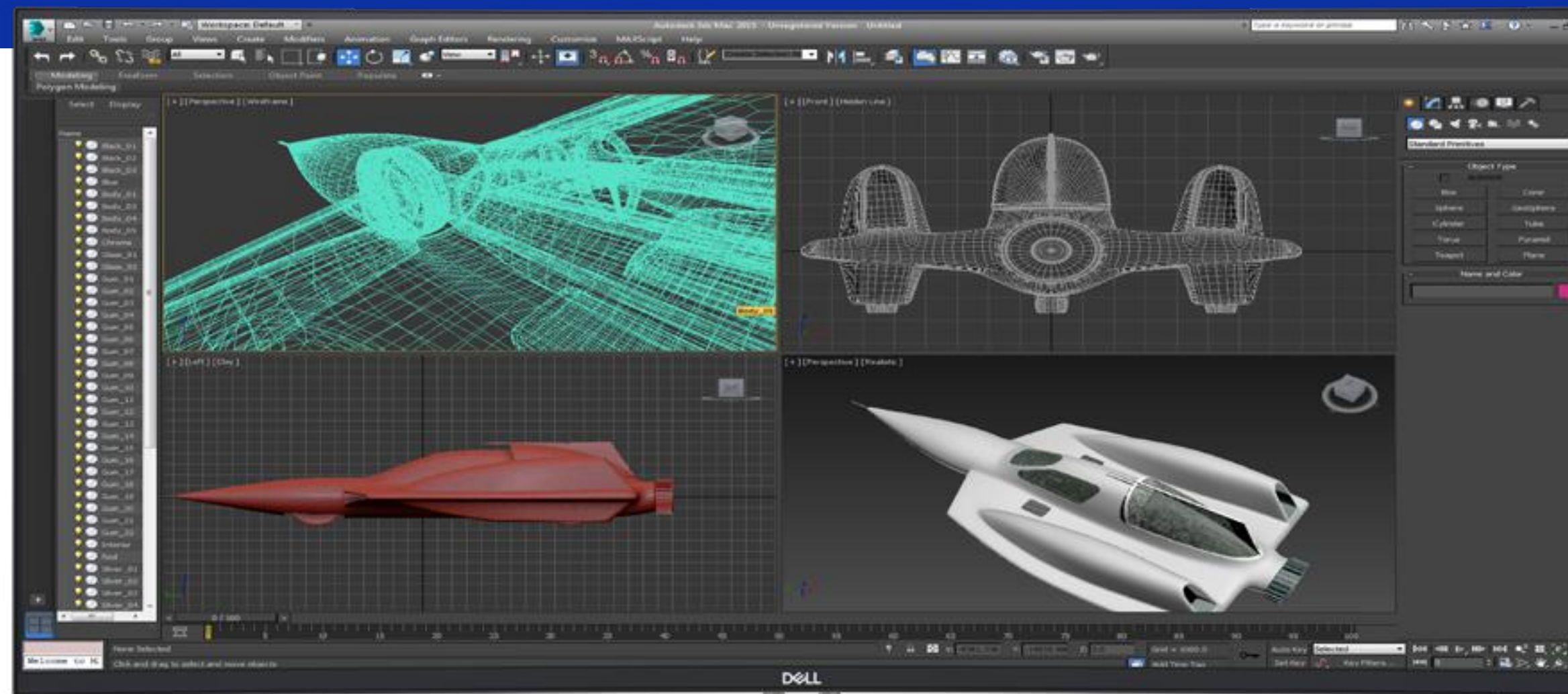

### Dell UltraSharp 38 Curved USB-C Hub Monitor | U3824DW

Experience clarity, productivity and connectivity on this 37.5" ultrawide WQHD+ curved hub monitor with 95% DCI-P3 color and integrated speakers.



### Dell Premier Multi-Device Wireless Keyboard and Mouse | KM7321W

Multi-task seamlessly across 3 devices with this premium full-size keyboard and sculpted mouse combo featuring programmable shortcuts and 36 months battery life.



### HTC Vive Pro 2

Review rendered projects in virtual reality and allow clients to experience a realistic interpretation of the finished product.

## Precision 5690

The smallest footprint 16" workstation with AI-based optimization\*

The Dell Precision 5690 Tower workstation delivers scalable performance for CAE applications, such as: Dassault Systemes – SolidWorks Visualize and CATIA Live Render, Autodesk – VRED, Arnold, PTC – Creo Rendering and Siemens – NX Ray Traced Studio.

The Precision 5690 has a premium look and feel that delivers exceptional performance. With an optional OLED UHD+ touch display ideal for color critical color visualization applications and 4 "Grade A" speakers, paired with up to NVIDIA RTX 5000 Ada Gen graphics it is an outstanding workstation for visualization and design applications.

\*Based on analysis of Dell 16" mobile workstation 5680 vs HP Zbook Studio G9, Lenovo Gen4 and Apple Macbook Pro 16, Feb 2023





**3Dconnexion SpaceMouse Pro**  
With an advanced ergonomic design and on-screen display, SpaceMouse Pro delivers superior comfort and a simpler, more productive workflow.

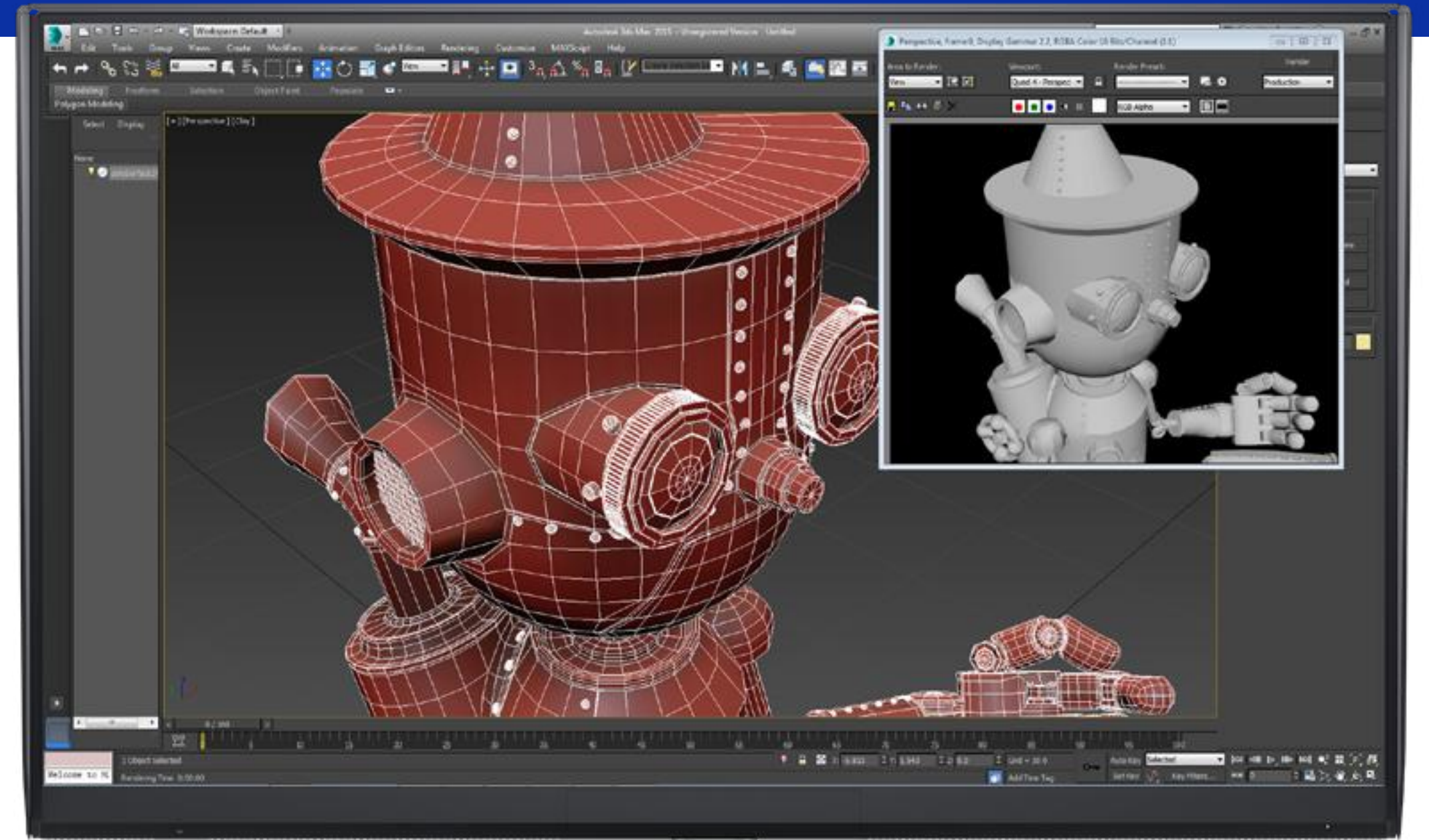

**Dell UltraSharp 32 HDR PremierColor Monitor | UP321Q**  
Create phenomenal 4K HDR content on the world's first professional monitor with 2K mini-LED direct backlit dimming zones.\*



**Dell Multi-Device Wireless Keyboard and Mouse | KM7120W**  
Compact layout on a full featured keyboard. Seamlessly switch between 3 devices anytime with a click of the button and enhance your productivity with its 36-month battery life. Multi-task seamlessly across 3 devices with this premium full-size keyboard and sculpted mouse combo featuring programmable shortcuts and 36 months battery life.



**Dell Performance Dock | WD19DCS**  
Boost your PC's power up to 210W on the world's most powerful and first modular dock with a future-ready design. Boost your PC's power up to 210W on the world's most powerful and first modular Dual USB-C dock with a future-ready design.



**VIVE Pro 2**  
Review rendered architectural projects in virtual reality and allow clients to experience a realistic interpretation of the finished product.





## Precision 3280 CFF Tower

The Dell Precision 3280 Compact Form Factor Tower workstation delivers scalable performance for CAM applications, such as: Autodesk HSMWorks, MasterCAM, Dassault Systemes DEMIA, SolidWorks CAM, PTC Creo, and Siemens NX CAM.

**You won't believe your eyes:**

Despite its compact form factor, the 3280 is equipped with the latest AMD Radeon™ Pro and NVIDIA® professional graphics to ensure a smooth and elevated visual experience every time.

**Slowing down isn't an option:**

Featuring 14th Gen Intel Core™ processors up to i9, NVIDIA® RTX 4000 SFF Ada graphics and 64GB RAM (5600MT/s) DDR5 memory. Also, get up to 9TBs of RAID capable storage.



### Dell UltraSharp 30 USB-C Hub Monitor | U3023E

Make more possible with this 30" 16:10 monitor with wide color coverage, multitasking features and a host of connectivity ports.



### 3Dconnexion SpaceMouse Pro Wireless | 3DX-700075

SpaceMouse® Pro Wireless offers professional 3D navigation, advanced ergonomic design, reliable connectivity with a high performance Universal Receiver and much more with up to two months of battery life.



### Dell Pro Wireless Keyboard and Mouse | KM5221W

Enhance your productivity and keep your desk clutter free with this expertly designed wireless keyboard and mouse combo. Powered by one of the industry's leading battery lives of up to 36 months, this combo is built to last.

## Precision 3591

Take your projects to new heights with exceptional workstation-class performance

The Dell Precision 3591 mobile workstation delivers scalable performance for CAM applications, such as: Autodesk HSMWorks, MasterCAM, Dassault Systemes DEMIA, SolidWorks CAM, PTC Creo, and Siemens NX CAM.AI and VR ready.

**Processor and operating system:** Fast and efficient Intel Core i5-i9, 14-16 cores with vPro options. Windows 11 Pro (with Windows 10 downgrades available).

**Graphics and color:** PremierColor, 100% sRGB, up to 400nits, and Intel integrated graphics (Iris Xe if dual-channel) with up to NVIDIA RTX 2000 ADA (8GB) graphics.

**Scalable memory:** Up to 64GB of DDR5 (2 DIMM) 5600 MT/s memory.





**Dell Dock |WD19 -180W or WD19S - 180W**  
Boost your workstation's power up to 130W with ExpressCharge on the world's most powerful and first modular dock with a future-ready design.



**Dell Multimedia Keyboard | KB216**  
The Dell Multimedia Keyboard provides a convenient keyboard solution for everyday office/factory computing uses.



**Dell UltraSharp 38 Curved USB-C Hub Monitor | U3824DW**  
Experience clarity, productivity and connectivity on this 37.5" ultrawide WQHD+ curved hub monitor with 95% DCI-P3 color and integrated speakers.



**Dell Laser Wired Mouse | MS3220**  
Work faster and smarter with the Dell Laser Wired Mouse – MS3220. The 3200 DPI sensitivity lets you navigate smoothly and easily across high-resolution 4K monitors

# Why Dell for Manufacturing & Engineering?

Dell Technologies helps engineering organizations efficiently bring products to market by supporting fast digital iteration in design, simulation and visualization workflows. In engineering, workstation horsepower translates into better product design, reduced physical prototypes, lower costs and faster time to market. Dell Precision workstations continue to form an integral part of that product development process.

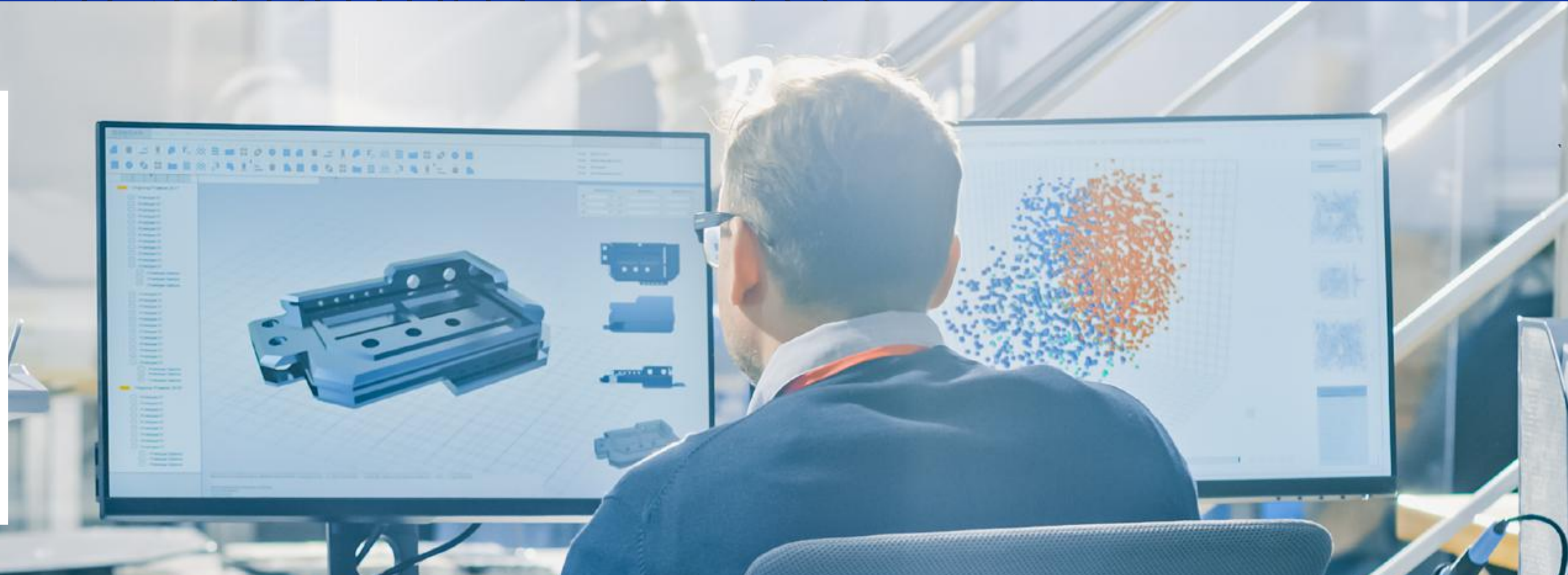

## INTELLIGENT PERFORMANCE

Dell Optimizer – Take personalized PC performance to the next level with built-in, AI-based optimization software that learns and responds to the way you work.

World's most powerful mobile, tower and rack workstations.

World's most scalable tower workstations.

ISV Certification – Workstations optimized for your apps.



## GROUND-BREAKING INNOVATION

First ready for XR and AI workstations, creating new categories.



## MISSION CRITICAL RELIABILITY

Fully ISV certified, tested, Mil Standard specifications.

Most secure and manageable workstations.  
OEM XL options available for extended life.



## ADVANCED THERMALS

Keep your system running cool and quietly for extended periods of time with User Selectable Thermal Tables, DOO fans and heat pipes.

# Dell Optimizer for Precision

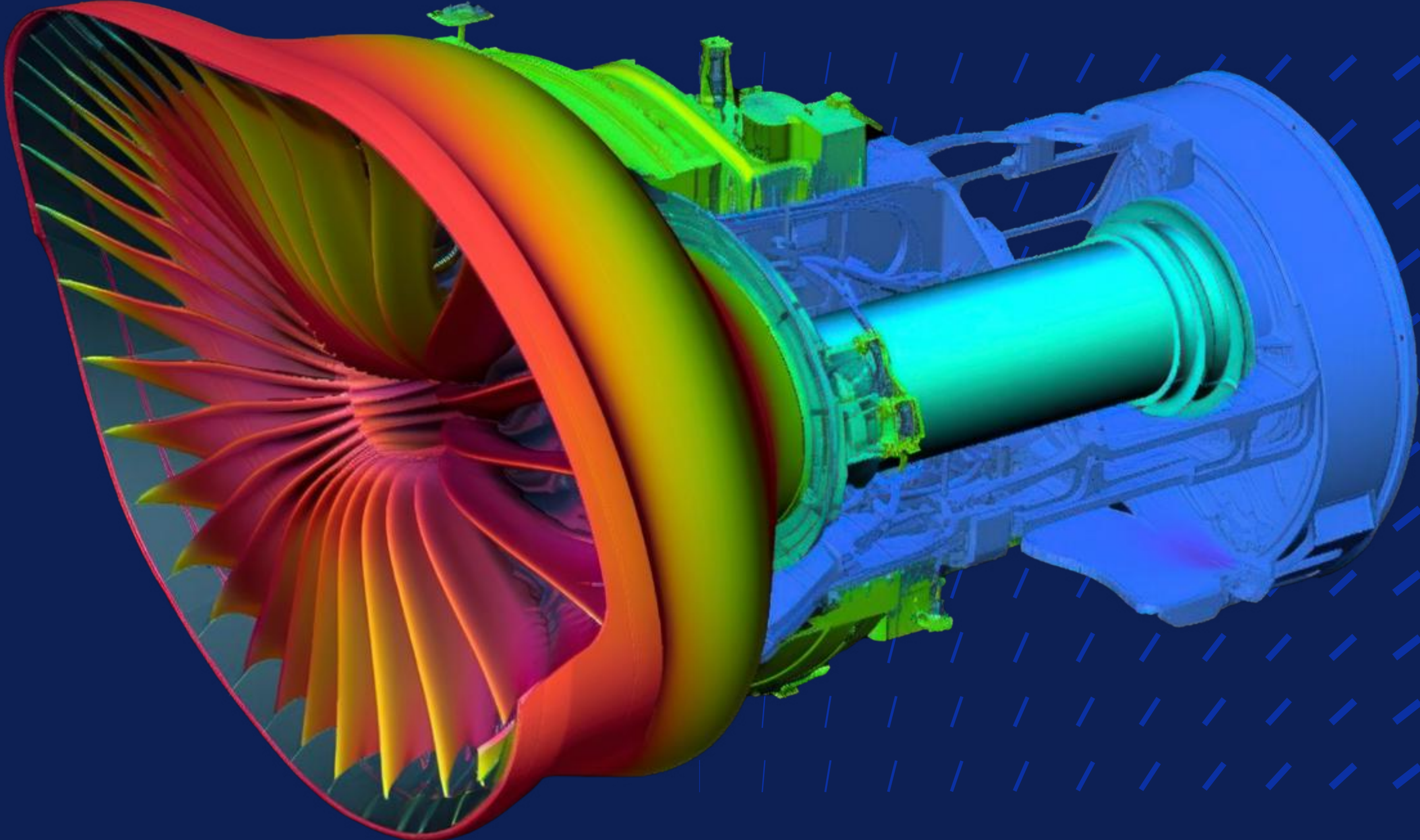



Transform your work experience with Dell Optimizer for Precision; the only built-in AI-based optimization software that learns and responds to the way you work.<sup>1</sup>

Dell Optimizer for Precision is built into all of our new Precision workstations. It provides all the optimization features from Dell Optimizer, plus an additional plugin in ExpressResponse to improve the performance of storage-heavy applications. It also identifies and removes bottlenecks with workload and system analytics, as well as diagnostics to improve utilization. With this built-in AI, you get professional-grade hardware and software for unmatched workstation performance.

<sup>1</sup>Based on Dell analysis, November 2019.

  
**Learn**  
the way you work

  
**Enhance**  
application performance

  
**Improve**  
battery run time

  
**Improve**  
audio experience

  
**Enable quicker sign-in,**  
and secure your system  
when you walk away

# ISV Certification

Dell partners with industry-leading technology companies to solve today's most complex problems in application computing.

## SEAMLESS RELIABILITY

ISV (Independent Software Vendor) certification means that the Dell Precision workstations you purchase are **tested to ensure that the high-performance applications you work with every day, run smoothly.**

## GET THE MOST OUT OF YOUR SOFTWARE APPLICATIONS

Independent Software Vendor (ISV) certification is the result of precise engineering and rigorous testing to optimize performance and reliability to run leading industry applications, allowing you to run leading industry applications with maximum confidence and performance.





Taking the next step

Unleash the full potential of AI in your manufacturing and engineering projects. Transform your deliverables with technology that amplifies productivity and ignites creativity.



Contact a Dell Technologies Solutions Expert

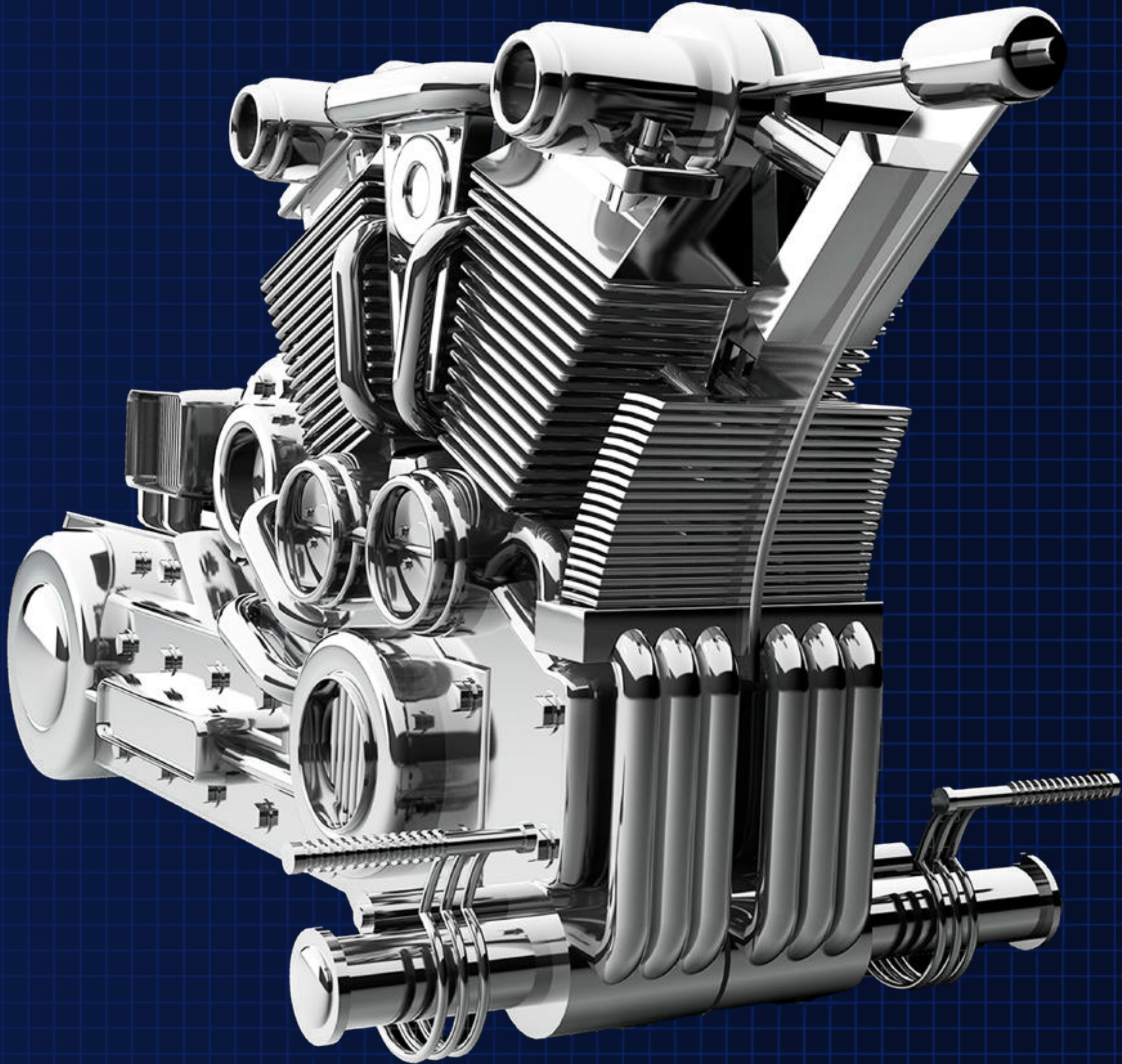

Follow us on social

